

24V C.C. - D.C.

VA01-BP70/LL-36A
VA01-BP70/LL-36S



- N°4 BORCHIE - ALTEZZA H=7.5
FORI Ø6.5 - INTERASSE Ø336.9 ±.2
- N°4 BOSSES - HEIGHT H=7.5
HOLES Ø6.5 - INTERAXLE Ø336.9 ±.2

- N°4 GANCI PER PERNI Ø6
INTERASSE Ø340.1 ±.2
- N°4 HOOKS Ø6
INTERASSE Ø340.1 ±.2

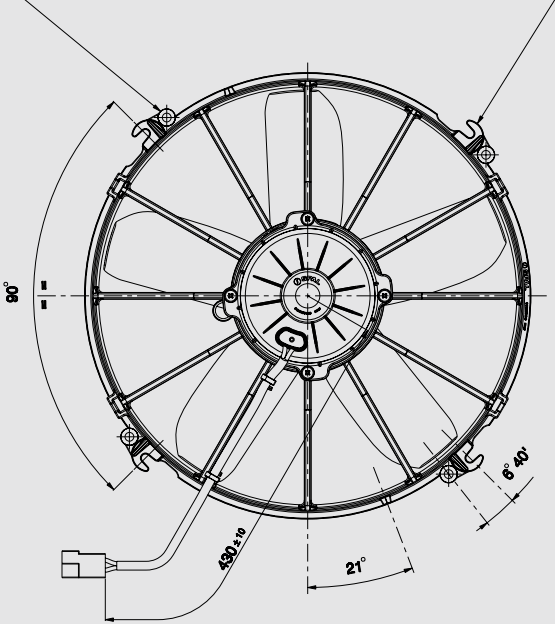

SEDE PER ANELLO IN GOMMA
RUBBER RING HOUSING

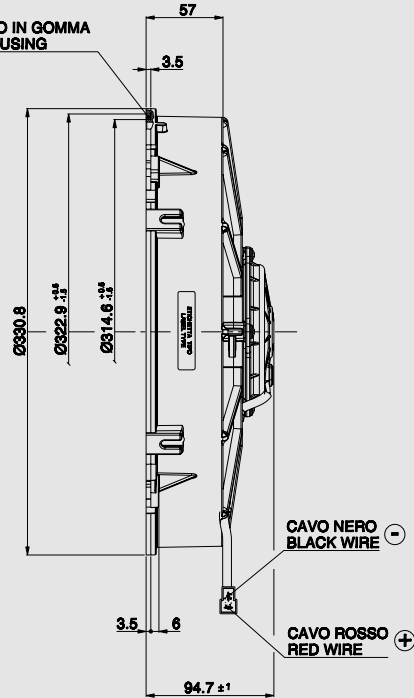

AMP connector Code 180908
AMP terminal Code 42098-2
Suggested mounting torque: 3(+1/-0) Nm with screw M5
Weight 2.35 Kg. approx.

Connettore AMP Cod. 180908
Terminali AMP Cod. 42098-2
Coppia di serraggio consigliata: 3(+1/-0) Nm con vite M5
Peso 2,35 Kg. circa

Ø 305 mm

Ø 12"

suction / aspirante

blowing / soffiante

PRODUCT FEATURES
CARATTERISTICHE PRODOTTO

Static pressure Pressione statica mm H ₂ O	suction / aspirante			blowing / soffiante			Static pressure Pressione statica inH ₂ O
	Airflow Portata m ³ /h	Current input Corrente assorbita A	Airflow Portata CFM	Airflow Portata m ³ /h	Current input Corrente assorbita A	Airflow Portata CFM	
0	2900	7,4	1711	2760	7,1	1628	0
5	2640	8,0	1558	2510	7,5	1481	0,2
10	2310	8,4	1363	2230	8,0	1316	0,4
15	1860	8,5	1097	1920	8,4	1133	0,6
20	1210	8,8	714	1470	8,6	867	0,8
25	900	9,2	531	1010	8,9	596	1
30	670	9,5	395	620	9,2	366	1,2
35	370	10,0	218	310	9,7	183	1,4
40	0	11,1	0	0	10,5	0	1,6

Waterproof motor, IP 68 Motore chiuso, IP 68	✓
Long life / Lunga durata	✓
VLL version* / Versione VLL*	✓
Waterproof connector Connettori a tenuta stagna	✓
Accessories: all the fixing kits Accessori: tutti i kit di fissaggio	✓

* for OEM applications only.
* per applicazioni OEM

✓ = Standard feature
Caratteristiche standard
✓ = Available upon request
Disponibile su richiesta

Test voltage 26 V. D.C. - Tensione di prova 26 V. c.c.